

GET IN TOUCH WITH ARTEOR™

A WORLD OF NEW POSSIBILITIES

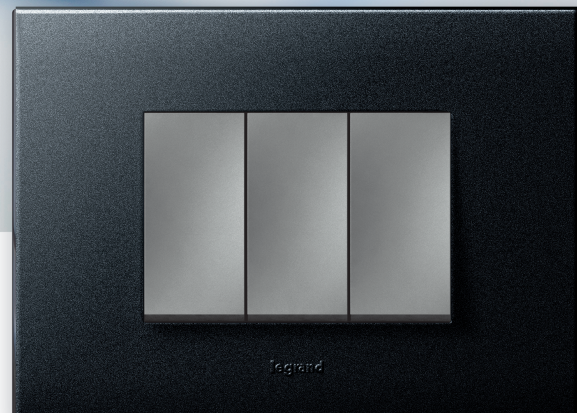

THE **GLOBAL SPECIALIST**
IN ELECTRICAL AND DIGITAL BUILDING INFRASTRUCTURES

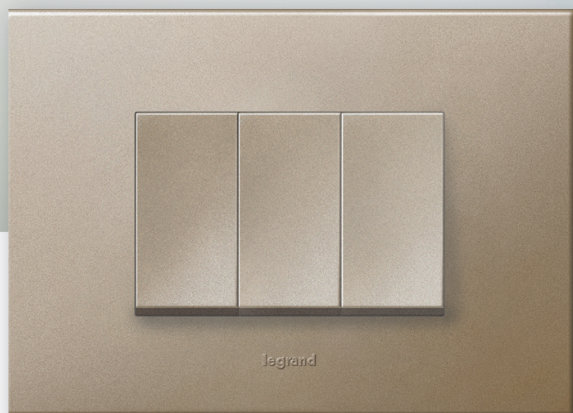

You can also choose to be different

Arteor's modularity allows for any kind of individual customized configuration, thus offering an unrivalled flexibility!

100% Arteor look

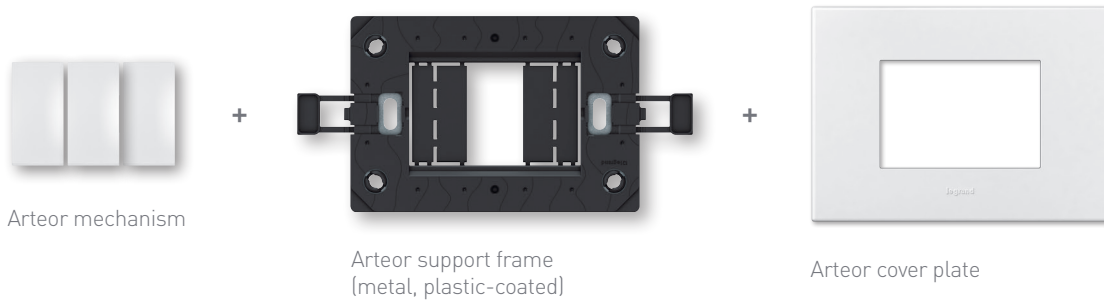

With 3 installation options for a solution to your liking!

Surface mounting

Arteor mechanism
+ surface-mounting box
+ support frame
+ cover plate

Flush-mounting

Arteor mechanism
+ flush-mounting box
+ support frame
+ cover plate

Weatherproof

Arteor mechanism
+ weatherproof box
+ weatherproof cover plate

Mosaic or Vela look

The Mosaic and Vela Cross plates change color to Brilliant White for a perfect match with Arteor mechanisms!





MAGNESIUM

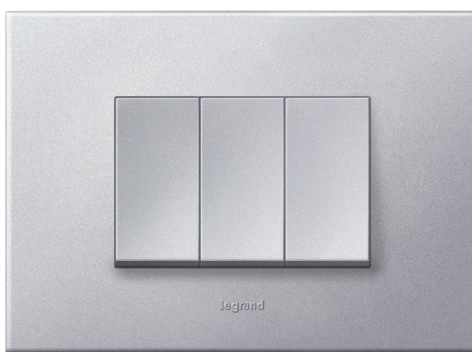

SOFT ALU

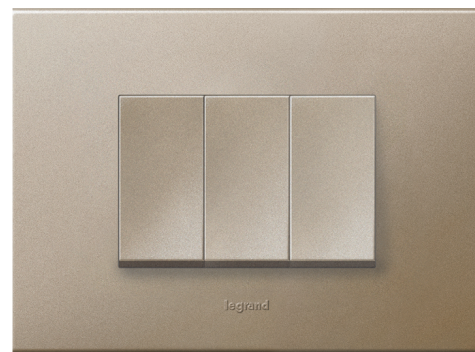

CHAMPAGNE

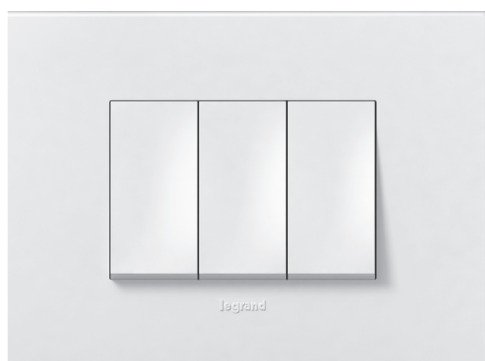

WHITE

NEUTRAL

FULL COLOUR

This neutral and minimalist collection leaves plenty of room for contemporary design concepts. An extended colour range with new plate and mechanism colours gives designers even greater freedom.

NEW COMBINATIONS

Arteor meets customisation requirements by offering more ways to combine colours.

But the more technology shapes our lives, the more we want it to blend in discreetly with our individual environments. This is why clean lines and a pared-down look define the design philosophy of the range.

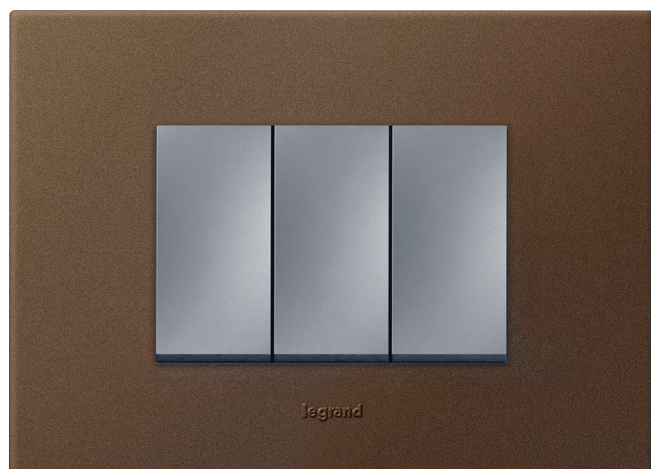

DARK BRONZE



GRAPHITE

Arteor™ mechanical switches



Support frame and plate selection chart page 9

Pack	Cat.Nos	Switches 10 AX - 250 V~
10	5 720 04	1-way switch <input type="radio"/> White - 1 module <input checked="" type="radio"/> Magnesium - 1 module <input type="radio"/> Champagne - 1 module <input type="radio"/> Soft Alu - 1 module
10	5 725 04	
10	5 700 04	
10	5 710 04	
10	5 724 50	
10	5 720 34	<input type="radio"/> White - 2 modules <input checked="" type="radio"/> Magnesium - 2 modules <input type="radio"/> Champagne - 2 modules <input type="radio"/> Soft Alu - 2 modules
10	5 725 34	
10	5 700 34	
10	5 710 34	
10	5 720 05	2-way switch <input type="radio"/> White - 1 module <input checked="" type="radio"/> Magnesium - 1 module <input type="radio"/> Champagne - 1 module <input type="radio"/> Soft Alu - 1 module
10	5 725 05	
10	5 700 05	
10	5 710 05	
10	5 720 35	<input type="radio"/> White - 2 modules <input checked="" type="radio"/> Magnesium - 2 modules <input type="radio"/> Champagne - 2 modules <input type="radio"/> Soft Alu - 2 modules
10	5 725 35	
10	5 700 35	
10	5 710 35	
10	5 720 06	<input type="radio"/> White - 1 module <input checked="" type="radio"/> Magnesium - 1 module <input type="radio"/> Champagne - 1 module <input type="radio"/> Soft Alu - 1 module
10	5 725 06	
10	5 721 75	
10	5 721 74	
5	5 720 36	<input type="radio"/> White - 2 modules <input checked="" type="radio"/> Magnesium - 2 modules <input type="radio"/> Champagne - 2 modules <input type="radio"/> Soft Alu - 2 modules
5	5 725 36	
5	5 721 77	
5	5 721 76	
5	5 720 08	Intermediate switch <input type="radio"/> White - 1 module <input checked="" type="radio"/> Magnesium - 1 module <input type="radio"/> Champagne - 1 module <input type="radio"/> Soft Alu - 1 module
5	5 725 08	
5	5 700 08	
5	5 710 08	
10	5 720 38	<input type="radio"/> White - 2 modules <input checked="" type="radio"/> Magnesium - 2 modules <input type="radio"/> Champagne - 2 modules <input type="radio"/> Soft Alu - 2 modules
10	5 725 38	
10	5 721 66	
10	5 721 65	

Pack	Cat.Nos	Switches 20 AX - 250 V~
5	5 720 14	1-way double pole switch with indicator Red LED supplied <input type="radio"/> White - 1 module <input checked="" type="radio"/> Magnesium - 1 module <input type="radio"/> Champagne - 1 module <input type="radio"/> Soft Alu - 1 module
5	5 725 14	
5	5 721 87	
5	5 721 86	
10	5 720 47	<input type="radio"/> White - 2 modules <input checked="" type="radio"/> Magnesium - 2 modules <input type="radio"/> Champagne - 2 modules <input type="radio"/> Soft Alu - 2 modules
10	5 725 47	
10	5 721 89	
10	5 721 88	
10	5 720 49	1-way double pole switch with indicator and "WATER HEATER" marking Red LED supplied <input type="radio"/> White - 2 modules <input checked="" type="radio"/> Magnesium - 2 modules <input type="radio"/> Champagne - 2 modules <input type="radio"/> Soft Alu - 2 modules
10	5 725 49	
10	5 721 91	
10	5 721 90	
10	5 720 48	2-way double pole switch <input type="radio"/> White - 2 modules <input checked="" type="radio"/> Magnesium - 2 modules <input type="radio"/> Champagne - 2 modules <input type="radio"/> Soft Alu - 2 modules
10	5 725 48	
10	5 721 93	
10	5 721 92	

Pack	Cat.Nos	Blank modules
10	5 723 41	1 module <input type="radio"/> White - square version <input checked="" type="radio"/> Magnesium - square version <input type="radio"/> Champagne - square version <input type="radio"/> Soft Alu - square version
10	5 728 41	
10	5 700 60	
10	5 710 60	
10	5 723 42	2 modules <input type="radio"/> White - square version <input checked="" type="radio"/> Magnesium - square version <input type="radio"/> Champagne - square version <input type="radio"/> Soft Alu - square version
10	5 728 42	
10	5 700 61	
10	5 710 61	
5	5 723 43	3 modules <input type="radio"/> White - square version <input checked="" type="radio"/> Magnesium - square version <input type="radio"/> Champagne - square version <input type="radio"/> Soft Alu - square version
5	5 728 43	
5	5 728 20	
5	5 728 19	



Support frames and plates, p. 8

Arteor™ push-buttons



Arteor™ mechanical switches



Support frame and plate selection charts p . 8

Support frame and plate selection charts p . 8

Pack Cat.Nos Push-buttons 6 A - 250 V~

Pack	Cat.Nos	Push-buttons 6 A - 250 V~
10	5 720 00	1-way push-button ○ White - 1 module ● Magnesium - 1 module ● Champagne - 1 module ● Soft Alu - 1 module
10	5 725 00	
10	5 700 00	
10	5 710 00	
10	5 720 30	1-way push-button with locator and bell symbol Equipped with blue LED ○ White - 1 module ● Magnesium - 1 module ● Champagne - 1 module ● Soft Alu - 1 module
10	5 725 30	
10	5 730 35	
10	5 730 34	
5	5 720 16	2-way push-button ○ White - 1 module ● Magnesium - 1 module ● Champagne - 1 module ● Soft Alu - 1 module
5	5 725 16	
5	5 730 41	
5	5 730 40	
10	5 720 01	2-way push-button with locator Equipped with blue LED ○ White - 1 module ● Magnesium - 1 module ● Champagne - 1 module ● Soft Alu - 1 module
5	5 725 01	
5	5 730 43	
5	5 730 42	
10	5 720 31	2-way push-button with locator Equipped with blue LED ○ White - 2 modules ● Magnesium - 2 modules ● Champagne - 2 modules ● Soft Alu - 2 modules
5	5 725 31	
5	5 730 45	
5	5 730 44	
10	5 720 02	2-way push-button with locator Equipped with blue LED ○ White - 1 module ● Magnesium - 1 module ● Champagne - 1 module ● Soft Alu - 1 module
10	5 725 02	
10	5 730 47	
10	5 730 46	
10	5 720 32	2-way push-button with locator Equipped with blue LED ○ White - 2 modules ● Magnesium - 2 modules ● Champagne - 2 modules ● Soft Alu - 2 modules
5	5 725 32	
5	5 730 49	
5	5 730 48	

		Curtain switches 1 module
5	5 722 02	Curtain switch centre off ○ White ● Magnesium ● Champagne ● Soft Alu
5	5 727 02	
5	5 700 52	
5	5 710 52	
5	5 722 01	Curtain push-button centre retract ○ White ● Magnesium ● Champagne ● Soft Alu
5	5 727 01	
5	5 727 55	
5	5 727 54	
		Electric roller blind controllers - 250 V~
		For control via automatic box (N/O mechanism) Double push-button - 10 A 2 modules
10	5 722 19	○ White ● Magnesium ● Champagne ● Soft Alu
10	5 727 19	
10	5 729 43	
10	5 729 42	
		For direct control of a motor (mechanism with fixed positions) Double push-button - 10 A 2 modules
10	5 722 20	○ White ● Magnesium ● Champagne ● Soft Alu
10	5 727 20	
10	5 700 54	
10	5 710 54	
		Overdoor lighting units Supplied with diffusers and LED 2 modules
10	5 722 23	○ White with red diffuser ○ White with white diffuser

Arteor™

international socket outlets



Pack	Cat.Nos	Multistandard socket outlets
10	5 721 23	2P+E unswitched - shuttered for child safety - 2 modules <ul style="list-style-type: none"> ○ White ● Magnesium ● Champagne ● Soft Alu
10	5 726 23	
10	5 700 42	
10	5 710 42	
5	5 721 32	British standard socket outlets Shuttered for child safety ASTA licence Conform to BS 1363 Part 2 Use special plates (p. 38) 2P+E switched - 15 A Conform to BS 546 3 modules <ul style="list-style-type: none"> ○ White ● Magnesium ● Champagne ● Soft Alu
5	5 726 32	
5	5 700 45	
5	5 710 45	
10	5 721 04	Euro-US type socket outlets - 15 A -127 V / 16 A - 250 V 2P with shutters - 1 module <ul style="list-style-type: none"> ○ White ● Magnesium ● Champagne ● Soft Alu
10	5 726 04	
10	5 700 37	
10	5 710 37	
10	5 721 03	Italian type socket outlets 2P+E shuttered for child safety - 10/16 A <ul style="list-style-type: none"> ○ White ● Magnesium ● Champagne ● Soft Alu
10	5 726 03	
10	5 700 36	
10	5 710 36	
10	5 721 24¹	Israeli type socket outlets 2P+E shuttered for child safety <ul style="list-style-type: none"> ○ White ● Magnesium ● Champagne ● Soft Alu ● Red
10	5 726 24 ¹	
10	5 700 43¹	
10	5 710 43¹	
10	5 721 24R	

Arteor™ USB chargers

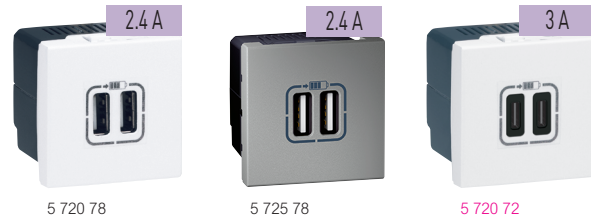

Pack	Cat.Nos	USB Type-A chargers
5	5 720 78¹	For recharging portable devices Conform to IEC 60950 Consumption in passive mode < 0.07 W 2P+E tap-off connection via 2 x 2.5 mm ² screw terminals Supplied without cord Double USB sockets - 5 V_{DC} - 2.4 A - 12 W For fast charging of smartphones and tablet PC 2 modules <ul style="list-style-type: none"> ○ White ● Magnesium ● Champagne ● Soft Alu
1	5 725 78¹	
1	5 710 76¹	
1	5 700 76¹	
10	5 720 71	Single USB sockets - 5 V_{DC} - 1.5 A - 5.5 W For Smartphone or Powerbank 1 module <ul style="list-style-type: none"> ○ White ● Magnesium ● Champagne ● Soft Alu
10	5 725 71	
10	5 710 75	
10	5 700 75	
1	N	USB Type-C chargers Used for charging the battery of a portable device without a mobile charger with USB Type-C plug Standby consumption < 0.07 W Conform to IEC 60950 Supplied without cord 1 USB Type-A + 1 USB Type-C - 230 V - 5 V_{DC} - 3 A - 15 W 2 modules <ul style="list-style-type: none"> ○ White ● Magnesium ● Champagne ● Soft Alu
1	5 720 77	
1	5 725 77	
1	5 710 77	
1	5 700 77	
1	5 720 72	2 USB Type-C - 230 V - 5 V_{DC} - 3 A - 15 W 2 modules <ul style="list-style-type: none"> ○ White ● Magnesium ● Champagne ● Soft Alu
1	5 725 72	
1	5 710 78	1 USB Type-C - 230 V - 5 V_{DC} - 1.5 A - 7.5 W 1 module <ul style="list-style-type: none"> ○ White ● Magnesium ● Champagne ● Soft Alu
1	5 700 78	
10	5 724 84	
10	5 733 94	
10	5 710 79	
10	5 700 79	

Arteor™ RJ 45 sockets



5 723 06 572806 572846 572845

Pack	Cat.Nos	Cat. 6_A sockets
		360° metal shielding
		STP - 1 module
10	5 723 06	○ White
10	5 728 06	● Magnesium
10	5 728 46	● Champagne
10	5 728 45	● Soft Alu
		UTP - 1 module
10	5 723 49	○ White
10	5 728 49	● Magnesium
10	5 728 65	● Champagne
10	5 728 64	● Soft Alu

Pack	Cat.Nos	Cat. 6 sockets
		UTP - 1 module
10	5 723 02	○ White
10	5 728 02	● Magnesium
10	5 700 57	● Champagne
10	5 710 57	● Soft Alu
		FTP - 1 module
10	5 723 22	○ White
10	5 728 22	● Magnesium
10	5 728 91	● Champagne
10	5 728 90	● Soft Alu
		STP shielded - 1 module
10	5 723 23	○ White
10	5 728 23	● Magnesium
10	5 728 95	● Champagne
10	5 728 94	● Soft Alu

Pack	Cat.Nos	Cat. 5e sockets
		UTP - 1 module
10	5 723 03	○ White
10	5 728 03	● Magnesium
10	5 700 58	● Champagne
10	5 710 58	● Soft Alu

Arteor™ telephone sockets & vision sockets



5 723 06 5 700 56 5 710 56 5 721 63 5 728 02

Pack	Cat.Nos	RJ 11 and RJ 12 sockets
		Equipped with modular Jack connector with 1/4 turn terminal for fast connection (possible looping)
		RJ 11 - 1 module
		4 contacts
10	5 723 00	○ White
10	5 728 00	● Magnesium
10	5 700 56	● Champagne
10	5 710 56	● Soft Alu

Pack	Cat.Nos	TV "F" type sockets
10	5 721 63	○ White
10	5 726 63	● Magnesium
10	5 700 50	● Champagne
10	5 710 50	● Soft Alu

Pack	Cat.Nos	Telephone sockets - single secondary
		With IDC connection. Conform to British Telecom
5	1 mod. 5 723 01*	○ White
5	5 728 01	● Magnesium



Pack	Cat.Nos	Lighting control
		Master switch - 2 modules 2-way double pole 20 AX - 250 V~ for general control: all ON / all OFF
10	5 732 84	<ul style="list-style-type: none"> ○ White ● Magnesium ● Champagne ● Soft Alu
10	5 737 84	
10	5 737 89	
10	5 737 88	
		Master push-button - 2 modules 2-way 6 A - 250 V~ for general control: all ON/ all OFF
10	5 732 86	<ul style="list-style-type: none"> ○ White ● Magnesium ● Champagne ● Soft Alu
10	5 737 86	
10	5 737 99	
10	5 737 98	
		Switch for bed lights - 2 x 1 module 2 x 2-way switch - 10 AX - 250 V~
10	5 732 94	<ul style="list-style-type: none"> ○ White ● Magnesium ● Champagne ● Soft Alu
5	5 737 94	
5	5 737 63	
5	5 737 62	
		Push-button for bed lights - 2 x 1 module 2 x 2-way push-button - 6 A - 250 V~
10	5 732 96	<ul style="list-style-type: none"> ○ White ● Magnesium
5	5 737 96	
		Electric roller blinds control - 250 VA
		Double switch 10 A - 2 modules For direct control of a motor (mechanism with fixed positions)
10	5 732 22	<ul style="list-style-type: none"> ○ White ● Magnesium ● Champagne ● Soft Alu
10	5 737 22	
10	5 737 76	
10	5 737 75	
		Double push-button 10 A - 2 modules For control via automatic box (N/O mechanism)
10	5 732 24	<ul style="list-style-type: none"> ○ White ● Magnesium
10	5 737 24	
		Curtain control - 250 VA
		Double switch 10 A - 2 modules For direct control of a motor (mechanism with fixed positions)
10	5 732 34	<ul style="list-style-type: none"> ○ White ● Magnesium
10	5 737 34	
		Double push-button 10 A - 2 modules For control via automatic box (N/O mechanism)
10	5 732 36	<ul style="list-style-type: none"> ○ White ● Magnesium
10	5 737 36	

Pack	Cat.Nos	Hotel bedroom call indicators
		Enable the resident to inform hotel staff of the room status Two settings are possible: - Do not disturb - Please clean the room 2 x 1 module
		Indicator for corridor Indicator lamp and bell push Installed in the corridor, display calls Supplied with LED
5	5 720 57	<ul style="list-style-type: none"> ○ White ● Magnesium ● Champagne ● Soft Alu
5	5 725 57	
5	5 737 78	
5	5 737 77	
		Internal control unit Allows the user to select the desired setting Supplied with LED
5	5 720 54	<ul style="list-style-type: none"> ○ White ● Magnesium ● Champagne ● Soft Alu
5	5 725 54	
5	5 737 82	
5	5 737 81	
		Mechanical key card switches For energizing a circuit by inserting a key fob Cat.No 5 722 59 or a smart card (access card for a hotel room) Example of use: hotel room power supply only when guest is present Time-delay of approx. 30 sec. after card removal To be equipped with single pole latching relay Cat.Nos 5 722 27 or 5 727 27 (p. 36) 2 modules
1	5 722 30	<ul style="list-style-type: none"> ○ White ● Magnesium ● Champagne ● Soft Alu
1	5 727 30	
1	5 700 55	
1	5 710 55	
		Key card switches RFID For energizing a circuit for example meeting room, office, hotel room... Works only with ISO type contactless key card Cat.Nos 0 767 11/12/13 or other ISO type 13.56 MHz key card Time-delay of approx. 30 sec. after card removal Low capacity contact 230 V - 30 VA Lighting of the slot by LED 2 modules
1	5 722 53	<ul style="list-style-type: none"> ○ White ● Magnesium ● Champagne ● Soft Alu
1	5 727 53	
1	5 727 37	
1	5 722 37	
		Shaver sockets 230 V / 120-230 V
1	5 721 55	<ul style="list-style-type: none"> ○ White ● Magnesium ● Champagne ● Soft Alu ○ White - with earth connector ● Magnesium - with earth connector ● Champagne - with earth connector ● Soft Alu - with earth connector
1	5 726 55	
1	5 726 66	
1	5 726 65	
1	5 721 53	
1	5 726 53	
1	5 727 64	
1	5 727 62	

Arteor™ Italian standards plates and support frames

83.5 mm fixing centres - flush-mounting boxes, support frames and plates



5 750 10



5 714 13



5 750 12



5 754 10



5 714 33



5 714 43



5 750 17

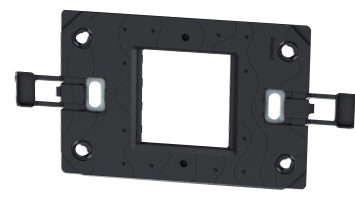

576040

Neutral - square version plates

Pack	Cat.Nos	1 module	2 modules	3 modules	4 modules	6 modules
10	5 752 20	 <ul style="list-style-type: none"> ○ Neutral - White ● Soft Alu ● Graphite ● Magnesium ● Champagne ● Dark Bronze 	 <ul style="list-style-type: none"> ○ Neutral - White ● Soft Alu ● Graphite ● Magnesium ● Champagne ● Dark Bronze 	 <ul style="list-style-type: none"> ○ Neutral - White ● Soft Alu ● Graphite ● Magnesium ● Champagne ● Dark Bronze 	 <ul style="list-style-type: none"> ○ Neutral - White ● Soft Alu ● Graphite ● Magnesium ● Champagne ● Dark Bronze 	 <ul style="list-style-type: none"> ○ Neutral - White ● Soft Alu ● Graphite ● Magnesium ● Champagne ● Dark Bronze
10	5 714 11					
10	5 752 22					
5	5 752 27					
10	5 714 31					
10	5 714 41					
10	5 752 30	 <ul style="list-style-type: none"> ○ Neutral - White ● Soft Alu ● Graphite ● Magnesium ● Champagne ● Dark Bronze 	 <ul style="list-style-type: none"> ○ Neutral - White ● Soft Alu ● Graphite ● Magnesium ● Champagne ● Dark Bronze 	 <ul style="list-style-type: none"> ○ Neutral - White ● Soft Alu ● Graphite ● Magnesium ● Champagne ● Dark Bronze 	 <ul style="list-style-type: none"> ○ Neutral - White ● Soft Alu ● Graphite ● Magnesium ● Champagne ● Dark Bronze 	
10	5 714 12					
10	5 752 32					
5	5 752 37					
10	5 714 32					
10	5 714 42					
10	5 750 10	 <ul style="list-style-type: none"> ○ Neutral - White ● Soft Alu ● Graphite ● Magnesium ● Champagne ● Dark Bronze 	 <ul style="list-style-type: none"> ○ Neutral - White ● Soft Alu ● Graphite ● Magnesium ● Champagne ● Dark Bronze 	 <ul style="list-style-type: none"> ○ Neutral - White ● Soft Alu ● Graphite ● Magnesium ● Champagne ● Dark Bronze 		
5	5 714 13					
5	5 750 12					
5	5 750 17					
5	5 714 33					
5	5 714 43					
5	5 750 30	 <ul style="list-style-type: none"> ○ Neutral - White ● Soft Alu ● Graphite ● Magnesium ● Champagne ● Dark Bronze 	 <ul style="list-style-type: none"> ○ Neutral - White ● Soft Alu ● Graphite ● Magnesium ● Champagne ● Dark Bronze 			
5	5 714 14					
5	5 750 32					
5	5 750 37					
5	5 714 34					
5	5 714 44					
5	5 750 40	 <ul style="list-style-type: none"> ○ Neutral - White ● Soft Alu ● Graphite ● Magnesium ● Champagne ● Dark Bronze 				
5	5 714 15					
5	5 750 42					
5	5 750 47					
5	5 714 35					
5	5 714 45					

Support frame for Italian type boxes 83.5 mm fixing centres

Pack	Cat.Nos	Screw mounting
10	5 760 03	 For 1 or 2 modules
10	5 760 40	 For 1 to 3 modules
5	5 760 11	 For 4 modules
5	5 760 12	 For 6 modules Horizontal mounting
2	5 760 22	 For 2 x 6 modules Horizontal mounting

Italian standard blanking cover plates

Pack	Cat.Nos	For 2" x 4" boxes
10	5 754 10	 <ul style="list-style-type: none"> ○ White ● Soft Alu ● Graphite ● Magnesium ● Champagne ● Dark Bronze
10	5 714 10	
10	5 754 12	
10	5 714 52	
10	5 714 53	
10	5 714 51	

Arteor™ support frames and cover plates



5 752 20



5 750 30

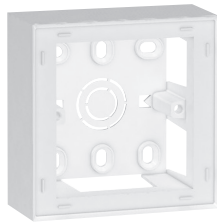

5 723 90

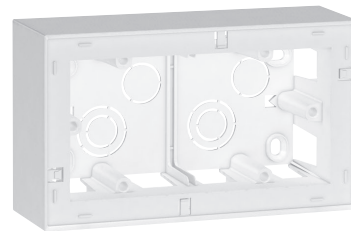

5 723 92

Pack Cat.Nos Arteor™ cover plates and support frames

Pack	Cat.Nos	Description
Cover plates		
1	5 752 20	To be mounted with Arteor support frames 1 module - White
1	5 752 30	2 modules - White
1	5 750 10	3 modules - White
1	5 750 30	4 modules - White
1	5 750 40	6 modules - White
Support frames		
10	5 760 40	3 modules For 1 to 3-module cover plates
5	5 760 11	4 modules
5	5 760 12	6 modules

Pack Cat.Nos Surface-mounting installation

10	5 723 90	1 gang – 1 or 2 modules Box - 38 mm depth
10	5 760 03	Support frame
1	5 752 00	Cover plate - 1 module - White
1	5 752 10	Cover plate - 2 modules - White

Pack Cat.Nos Surface-mounting installation (continued)

5	5 723 92	4 or 2 x 2 modules Box - 48 mm depth
5	5 760 11	Support frame
1	5 750 30	Cover plate - White
1	5 723 96	2 x 6 modules Box - 48 mm depth
2	5 760 22	Support frame
1	5 750 60	Cover plate - White

Pack Cat.Nos Flush-mounting installation

1	0 801 26	2 x 6 modules Multimaterial box 50 mm depth 213 x 142 mm
2	5 760 22	Support frame
1	5 750 60	Cover plate - White

Arteor™ support frames and cover plates (continued)



6 806 33

Mosaic / Vela Cross cover plates and SPX support frames









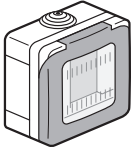
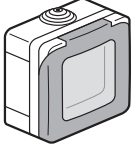
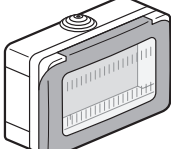
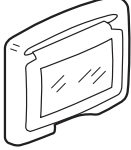
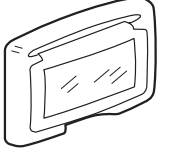

0 750 75

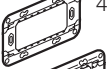
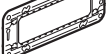

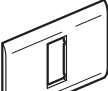
6 805 67

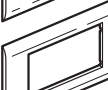
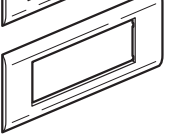
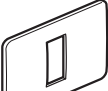
To be mounted with Arteor mechanisms pages 4-7

Pack	Cat.Nos	Weatherproof installation
Boxes		
1	6 806 11	 1 module
1	6 806 12	 2 modules
1	6 806 13	 3 modules
Cover plates		
1	6 806 32	 3 modules - White
1	6 806 33	
1	6 806 34	 4 modules - White
1	6 806 35	
SPX support frames for Mosaic Cross & Vela Cross cover plates		
100	0 728 43	 3 modules. For 1 to 3-module cover plates
10	0 728 44	 4 modules
10	0 728 46	 6 modules

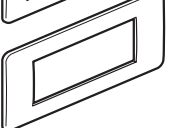
Pack	Cat.Nos	Mosaic Cross cover plates
To be mounted with SPX support frames		
1	0 750 75	○ Brilliant White  1 module
1	0 750 76	 2 modules
1	0 750 77	 3 modules
1	0 750 80	 4 modules
1	0 750 84	 6 modules
Vela Cross basic cover plates		
To be mounted with SPX support frames		
1	6 805 65	○ Brilliant White  1 module
1	6 805 66	 2 modules
1	6 805 67	 3 modules
1	6 805 68	 4 modules
1	6 805 69	 6 modules

Your Distributor

Shaer United Co. for Modern Technology

180 Main Street, Beit Jala - PALESTINE

Tel. 02 2765840 Fax 02 2747355

Mobile 0599 211 401 / 0599 211 403 / 0599 211 404

E-mail: info@shaer.ps | <http://www.shaer.ps>



Head Office

and International Department
87045 Limoges Cedex - France
Tel: +33(0)5 55 06 87 87
Fax: +33(0)5 55 06 74 55